

DALI CW-WW LED Dimmer CC

Datasheet Control Gear



DALI LED Dimmer (CC, DT8) for
the control of tunable white
luminaires (CW-WW)

common plus connector:

Art. Nr. 86458911-350 (350mA)

Art.Nr. 86458911-350DE (350mA)

Art. Nr. 86458911-500 (500mA)

Art. Nr. 86458911-500DE (500mA)

Art. Nr. 86458911-700 (700mA)

Art. Nr. 86458911-1000 (1000mA)

common minus connector:

Art.Nr. 86458911-350GMDE (350mA)

Art.Nr. 86458911-500GMDE (500mA)

Art. Nr. 86458911-700GM (700mA)

Art. Nr. 86458911-1000GM (1000mA)

DALI CW-WW LED-Dimmer CC Control Gear

Overview

- DALI LED-Dimmer for the control of tunable white luminaires
- suitable for constant current LED-modules
- **Operating Mode DT8:** one DALI-address for the independent control of light level and colour temperature (DALI DT8, Colour Type Tc)
- **Operating Mode Balance&Dim:** control by 2 DALI-addresses, one for adjusting the light level and one for adjusting the channel balance (e.g. colour temperature)
- **Operating Mode Dim2Warm:** one DALI-address for simultaneous adjustment of light level and colour temperature
- **SwitchDim2:** 2 switch-inputs offer control of level and colour without DALI
- dimming range 0.1%-100%
- adjustable PWM-frequency (122Hz/244Hz/488Hz/976Hz)
- types for constant currents of 350mA, 500mA, 700mA and 1000mA
- types with common plus and common minus connector available
- compact types for integration in luminaires or remote ceiling
- supply voltage from 12V to 48V DC
- output voltage up to 45VDC
- integrated short circuit protection
- low standby power consumption
- high efficiency
- configuration via PC-software DALI-Cockpit and DALI USB-interface
- user-friendly factory default settings

Specification, Characteristics

common plus connector:

type	DALI CW-WW 350/500mA	DALI CW-WW 350/500mA DE	DALI CW-WW 700mA	DALI CW-WW 1000mA
article number	86458911-350 / 86458911-500	86458911- 350DE/500DE	86458911-700	86458911-1000

electrical data:

supply voltage V_{in}	12VDC-48VDC			
max. input current I_{inmax}	350mA / 500mA	350mA / 500mA	700mA	1000mA
max. output current I_{led}	350mA / 500mA	350mA / 500mA	700mA	1000mA
output voltage range V_{led}	3V-45V (at 48V supply)			
control input	DALI	DALI SwitchDim2		
current consumption DALI	2mA			
number of DALI-addresses	operating mode DT8, Dim2Warm: 1 operating mode Balance&Dim: 2			
standby power consumption (12V)	~ 180 mW			

type	DALI CW-WW 350/500mA	DALI CW-WW 350/500mA DE	DALI CW-WW 700mA	DALI CW-WW 1000mA
technical data:				
power on behaviour	configurable via DALI: 0%-100% or last value			
storage and transportation temperature	-20°C to +75°C			
operational ambient temperature	-20°C to +60°C			
expected lifetime	>100000h at Tc<75°C			
protection class	IP20			
max. connecting wire cross section	up to 1.5 mm ²	up to 1.5 mm ² , supply (V+, V-): up to 2.5 mm ²		
dimensions (LxWxH)	59mm x 33mm x 15mm	120mm x 30mm x 22mm	120mm x 41mm x 22mm	
housing/mounting	back box	remote ceiling		

on request: output currents from 100mA to 1000mA available

for constant currents up to 500mA:

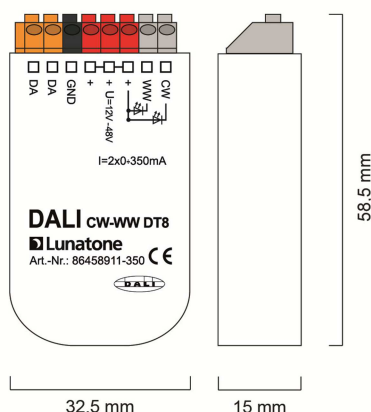

dimensions (common plus, back box)

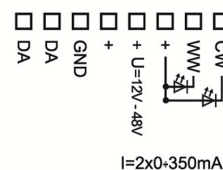

connection plan (common plus, back box)

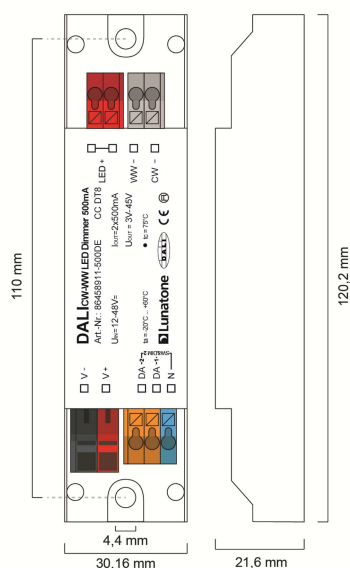

dimensions (common plus, remote ceiling)



connection plan (common plus, remote ceiling)

for constant currents >500mA

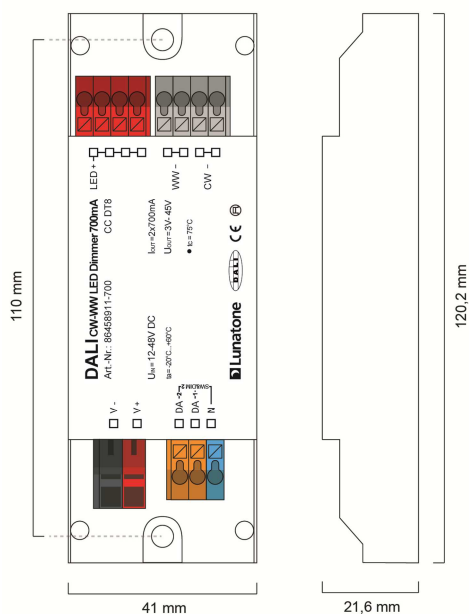

dimensions (common plus, remote ceiling)

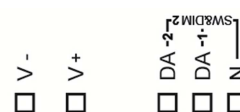
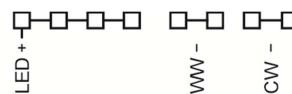

connection plan (common plus, remote ceiling)

common minus connector:

type	DALI CW-WW 350/500mA GMDE	DALI CW-WW 700mA GM	DALI CW-WW 1000mA GM
article number	86458911- 350GMDE/500GMDE	86458911-700GM	86458911-1000GM

electrical data:

supply voltage V_{in}	12VDC-48VDC		
max. input current I_{inmax}	350/500mA	700mA	1000mA
max. output current I_{led}	350/500mA	700mA	1000mA
output voltage range V_{led}	3V-45V (at 48V supply)		
control input	DALI SwitchDim2		
current consumption DALI	2mA		
number of DALI-addresses	operating mode DT8, Dim2Warm: 1 operating mode Balance&Dim: 2		
standby power consumption (12V)	180 mW		

technical data:

power on behaviour	configurable via DALI: 0%-100% or last value		
storage and transportation temp.	-20°C bis +75°C		
operational ambient temperature	-20°C bis +60°C		
expected lifetime	>100000h (at $T_c < 75^\circ\text{C}$)		
protection class	IP20		
max. connecting wire cross section	up to 1.5 mm ² , supply (V+, V-): up to 2.5 mm ²		
dimensions (LxWxH)	120mmx30mmx22mm	120mmx41mmx22mm	
housing/mounting	remote ceiling		

on request: output currents from 100mA to 1400mA available

for constant currents up to 500mA (on request up to 700mA):

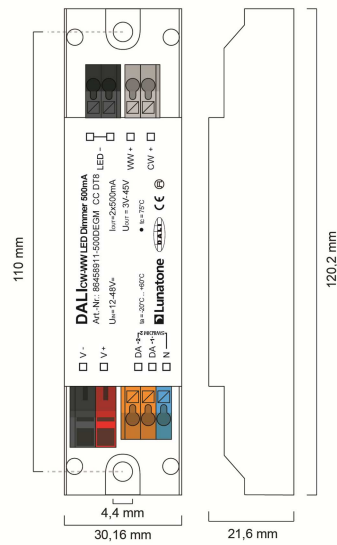

dimensions (common minus, remote ceiling)

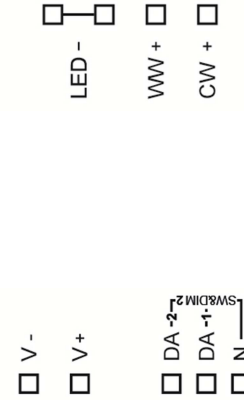

connection plan

for constant currents > 500mA:

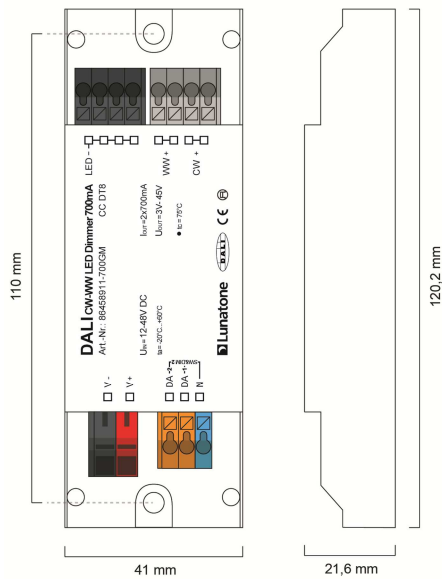

dimensions (common minus, remote ceiling)

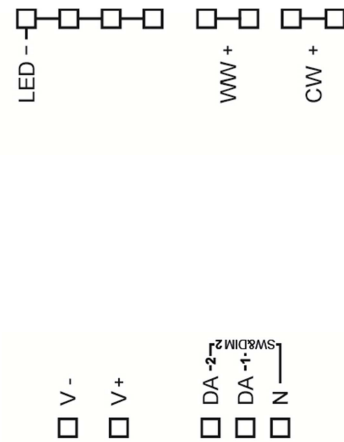

connection plan



Hint:

For highest efficiency the input voltage should range between 3V and 10V above the LED-voltage:

- 4-6 LEDs: 24V
- 6-9LEDs: 36V
- 10-12 LEDs: 48V

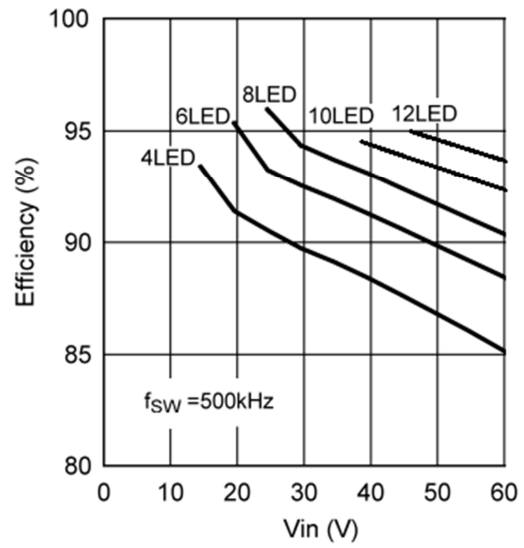

DALI (common plus connector type):

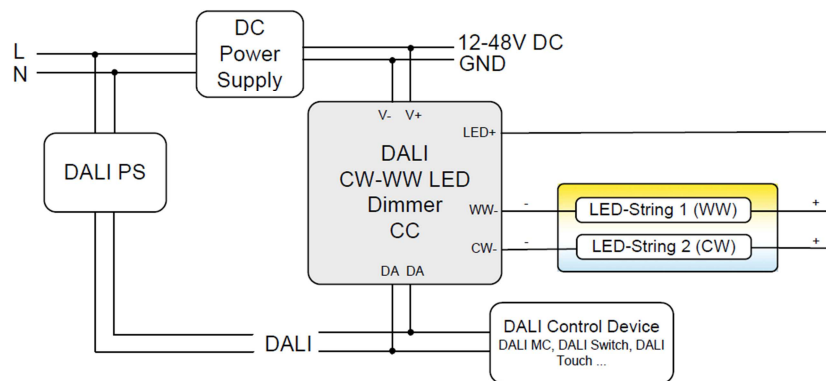

SwitchDim2 (common plus connector type):

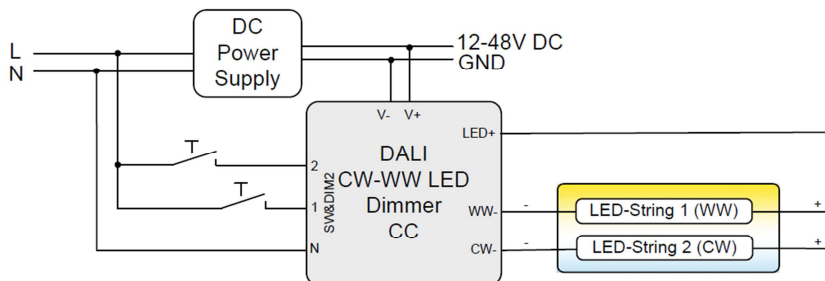

Operating Modes

The device offers several operating modes:

DT8 (factory default)

Default when connected to DALI in this operating mode one DALI-address for the independent control of light level and colour temperature is used (Device Type 8 Mode Tc).

Alternatively the device can be controlled using 2 switch-inputs for mains voltage (SwitchDim2):

SwD1: light level

short press: On/Off

long press: dimming

SwD2: colour temperature

long press: change colour temperature

Balance&Dim

This operating mode is also suitable for operating tunable white luminaires using two DALI-addresses. The first controls the light level and the second is used for changing the distribution on the output channels (e.g. for tunable white applications or balancing direct/indirect lighting).

The Balance&Dim mode allows colour temperature adjustments without affecting the light level and vice versa. For each channel only DALI-standard commands like dim up/down but also DAP are used. Thus the device can be used with all common controls and gateways (e.g. KNX). The Balance&Dim mode provides an alternative to the DT8-Tc mode.

Can be operated via DALI or SwitchDim2:

DALI-address 1, SwD1: light level

DALI-address 2, SwD2: balance

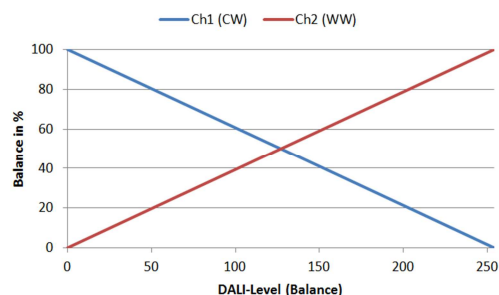

Dim2Warm

Both output channels are controlled by one DALI-address or SwD-input. The balance is coupled directly to the DALI dim level – the smaller the dim level the warmer the light.

DALI-address 1, SwD1: Dim2Warm (Master)

short press: On/Off

long press: dimming

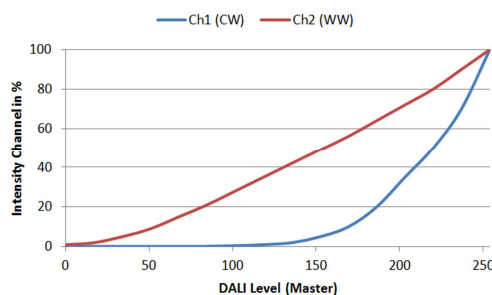

SwD2: scene selector

Selection of operating mode

With the help of the PC-software tool DALI-Cockpit the operating mode can be easily set on the general settings page.

Operating mode DT8-Tc:

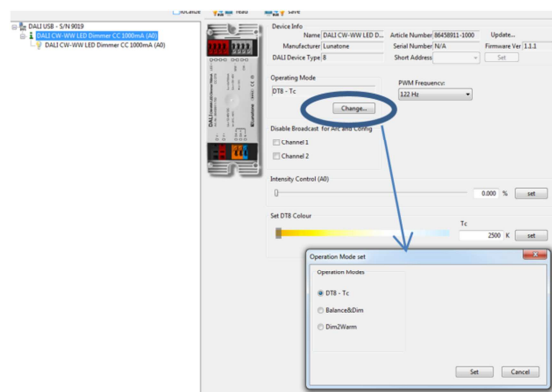

In addition, on the same page the PWM-frequency can be selected and basic control elements for testing each operating modes are available (DT8: slider for level and colour temperature, Balance&Dim: slider for level and balance, Dim2Warm: slider for input value adaption and Edit-Function for the Dim2Warm-table). Furthermore the broadcast control can be deactivated for each channel individually.

Operating Mode Balance&Dim:

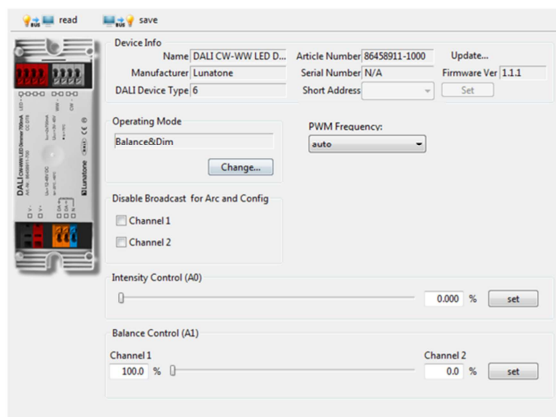

Operating Mode Dim2Warm:

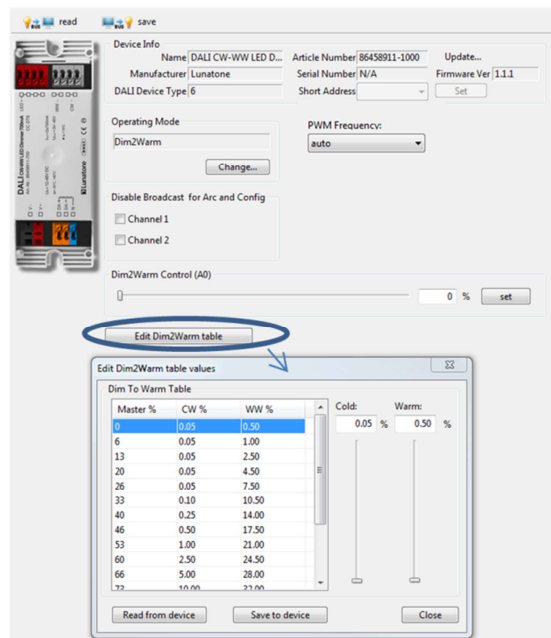

Switching between operating modes can also be done with the help of the DALI-command SET OPERATING MODE (IEC 62386-102 Ed.2). When changing the operating mode the number of used DALI-addresses can change as

well and this requires a new addressing procedure. In the DALI-Cockpit this address assignment is performed automatically.

Operating Mode:

Number	Operating Mode
0x0	DT8 (factory default)
0x92	DT8
0x94	Balance&Dim
0x95	Dim2Warm

Additional Settings

Besides the settings on the general page each channel can be selected separately in the component tree for individual configuration.

Component Tree:

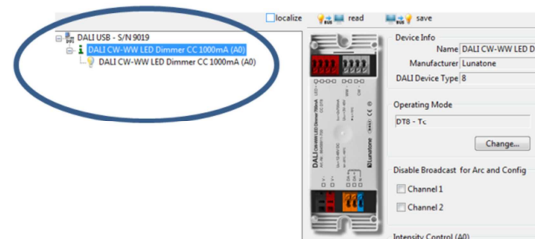

Settings in the operating mode DT8-Tc (displayed parameters are the factory default values):

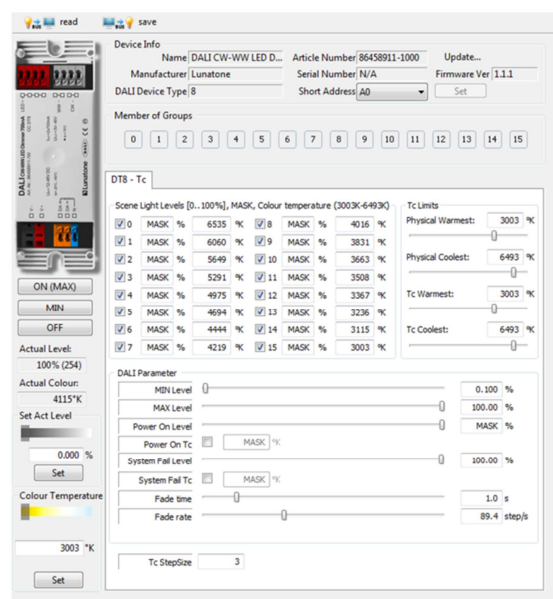

Beside the DT8 Tc standard settings, the Tc stepsize can be increased, this is a simple way to speed up colour temperature changes when using the commands TC STEP COOLER/WARMER.

In all other operating modes (Balance&Dim /Dim2Warm) the following settings are provided.

Operating mode Balance&Dim; Dim2Warm:

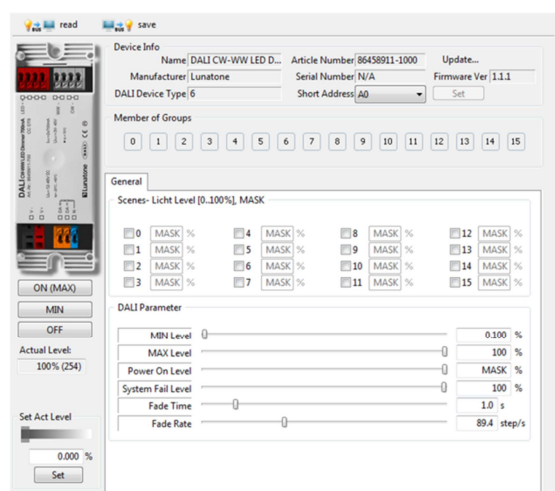

For each address the group membership can be set as well as scene values and DALI-parameters. In Balance&Dim operating mode all values assigned to channel 2 are representing the balance.

Factory Default Settings

Before the initial addressing is performed, the device can already be controlled by a group address. This predefined grouping will be deleted during the first addressing procedure. Afterwards groups can be assigned as usual (e.g. with the help of the DALI Cockpit). By sending a DALI-Reset command the device is set to the default values defined in the standard.

Summary of the factory default settings (delivery state):

operating mode	DT8																																																																																																
SwitchDim2	SwD1: level SwD2: colour temperature																																																																																																
Min Level	0.1%																																																																																																
PowerOn Level	MASK (last value)																																																																																																
Fade Time	2 (1s)																																																																																																
Fade Rate	5 (89.4 steps/s)																																																																																																
Tc-Stepsize	3 increments																																																																																																
PWM-frequency	122Hz																																																																																																
Groups before initial addressing:	G0 (or G0 and G1 in operating mode Balance&Dim)																																																																																																
Predefined Scene Values:	<table border="1"> <tr><td><input checked="" type="checkbox"/></td><td>0</td><td>MASK</td><td>%</td><td>6535</td><td>°K</td><td><input checked="" type="checkbox"/></td><td>8</td><td>MASK</td><td>%</td><td>4016</td><td>°K</td></tr> <tr><td><input checked="" type="checkbox"/></td><td>1</td><td>MASK</td><td>%</td><td>6060</td><td>°K</td><td><input checked="" type="checkbox"/></td><td>9</td><td>MASK</td><td>%</td><td>3831</td><td>°K</td></tr> <tr><td><input checked="" type="checkbox"/></td><td>2</td><td>MASK</td><td>%</td><td>5649</td><td>°K</td><td><input checked="" type="checkbox"/></td><td>10</td><td>MASK</td><td>%</td><td>3663</td><td>°K</td></tr> <tr><td><input checked="" type="checkbox"/></td><td>3</td><td>MASK</td><td>%</td><td>5291</td><td>°K</td><td><input checked="" type="checkbox"/></td><td>11</td><td>MASK</td><td>%</td><td>3508</td><td>°K</td></tr> <tr><td><input checked="" type="checkbox"/></td><td>4</td><td>MASK</td><td>%</td><td>4975</td><td>°K</td><td><input checked="" type="checkbox"/></td><td>12</td><td>MASK</td><td>%</td><td>3367</td><td>°K</td></tr> <tr><td><input checked="" type="checkbox"/></td><td>5</td><td>MASK</td><td>%</td><td>4694</td><td>°K</td><td><input checked="" type="checkbox"/></td><td>13</td><td>MASK</td><td>%</td><td>3236</td><td>°K</td></tr> <tr><td><input checked="" type="checkbox"/></td><td>6</td><td>MASK</td><td>%</td><td>4444</td><td>°K</td><td><input checked="" type="checkbox"/></td><td>14</td><td>MASK</td><td>%</td><td>3115</td><td>°K</td></tr> <tr><td><input checked="" type="checkbox"/></td><td>7</td><td>MASK</td><td>%</td><td>4219</td><td>°K</td><td><input checked="" type="checkbox"/></td><td>15</td><td>MASK</td><td>%</td><td>3003</td><td>°K</td></tr> </table>	<input checked="" type="checkbox"/>	0	MASK	%	6535	°K	<input checked="" type="checkbox"/>	8	MASK	%	4016	°K	<input checked="" type="checkbox"/>	1	MASK	%	6060	°K	<input checked="" type="checkbox"/>	9	MASK	%	3831	°K	<input checked="" type="checkbox"/>	2	MASK	%	5649	°K	<input checked="" type="checkbox"/>	10	MASK	%	3663	°K	<input checked="" type="checkbox"/>	3	MASK	%	5291	°K	<input checked="" type="checkbox"/>	11	MASK	%	3508	°K	<input checked="" type="checkbox"/>	4	MASK	%	4975	°K	<input checked="" type="checkbox"/>	12	MASK	%	3367	°K	<input checked="" type="checkbox"/>	5	MASK	%	4694	°K	<input checked="" type="checkbox"/>	13	MASK	%	3236	°K	<input checked="" type="checkbox"/>	6	MASK	%	4444	°K	<input checked="" type="checkbox"/>	14	MASK	%	3115	°K	<input checked="" type="checkbox"/>	7	MASK	%	4219	°K	<input checked="" type="checkbox"/>	15	MASK	%	3003	°K
<input checked="" type="checkbox"/>	0	MASK	%	6535	°K	<input checked="" type="checkbox"/>	8	MASK	%	4016	°K																																																																																						
<input checked="" type="checkbox"/>	1	MASK	%	6060	°K	<input checked="" type="checkbox"/>	9	MASK	%	3831	°K																																																																																						
<input checked="" type="checkbox"/>	2	MASK	%	5649	°K	<input checked="" type="checkbox"/>	10	MASK	%	3663	°K																																																																																						
<input checked="" type="checkbox"/>	3	MASK	%	5291	°K	<input checked="" type="checkbox"/>	11	MASK	%	3508	°K																																																																																						
<input checked="" type="checkbox"/>	4	MASK	%	4975	°K	<input checked="" type="checkbox"/>	12	MASK	%	3367	°K																																																																																						
<input checked="" type="checkbox"/>	5	MASK	%	4694	°K	<input checked="" type="checkbox"/>	13	MASK	%	3236	°K																																																																																						
<input checked="" type="checkbox"/>	6	MASK	%	4444	°K	<input checked="" type="checkbox"/>	14	MASK	%	3115	°K																																																																																						
<input checked="" type="checkbox"/>	7	MASK	%	4219	°K	<input checked="" type="checkbox"/>	15	MASK	%	3003	°K																																																																																						

Purchase Order Information

Art.Nr. 86458911-xxx: DALI CW-WW LED Dimmer, CC – constant current xxxmA, **common plus connector**, supply 12V-48V DC, output voltage range: 3V-45V , 100mA - 500mA, back box

Art.Nr. 86458911-xxxDE: DALI CW-WW LED Dimmer, CC – constant current xxxmA, **common plus connector**, supply 12V-48V DC, output voltage range: 3V-45V, **SwitchDim2**, 100mA-500mA, remote ceiling & integration in luminaires

Art.Nr. 86458911-xxx: DALI CW-WW LED Dimmer, CC – constant current xxxmA, **common plus connector**, supply 12V-48V DC, output voltage range: 3V-45V, **SwitchDim2**, 500mA -1000mA, remote ceiling & integration in luminaires

Art.Nr. 86458911-xxxGMDE: DALI CW-WW LED Dimmer, CC – constant current xxxmA,

common minus connector, supply 12V-48V DC, output voltage range: 3V-45V,
SwitchDim2, 100mA-500mA, remote ceiling & integration in luminaires

Art.Nr. 86458911-xxxGM: DALI CW-WW LED Dimmer, CC – constant current xxxmA,
common minus connector, supply 12V-48V DC, output voltage range: 3V-45V,
SwitchDim2, 500mA -1400mA, remote ceiling & integration in luminaires

Additional Information and Equipment

DALI-Cockpit – free configuration tool from Lunatone for DALI systems
<http://lunatone.at/en/downloads/Lunatone-DALI-Cockpit.zip>

Lunatone DALI products
<http://www.lunatone.at/en/>

Lunatone datasheets and manuals
<http://lunatone.at/en/downloads/>

Contact

Technical Support: support@lunatone.com

Requests: sales@lunatone.com

www.lunatone.com



Disclaimer

Subject to change. Information provided without guarantee.
The datasheet refers to the current delivery.

The compatibility with other devices must be tested in advance to the installation.