

DALI PD

Datasheet

Phase Dimmer Module

Phase Dimmer with
DALI control input (DT4)

DALI PD:

Art. Nr. 86458618 (RL)

Art. Nr. 86458619 (RC)

Art. Nr. 86458619-25U (RLC)

DALI PD300:

Art. Nr. 86458618-300 (RL)

Art. Nr. 86458619-300 (RC)

Art. Nr. 86458619-300U (RLC)

Art.Nr. 86458619-300U-HS (RLC HS)



DALI PD Phase Dimmer Module

Overview

- Suitable for dimming of 230V LED-retrofit-bulbs via DALI (Device Type 4 from firmware 3.0 and higher)
- different types for loads from 3W to 25W (PD) for back box installation and for 10-300W (PD300) for remote ceiling and din rail
- trailing edge phase cut dimmer for resistive and capacitive loads, leading edge phase cut dimmer for resistive and inductive loads as well available as universal dimmer
- conversion of the DALI dimlevel into a phase cut controlled voltage (trailing/leading edge)
- the minimum dim level can be set via DALI (MIN LEVEL)
- additional operating mode as switch (DT7 compliant) available with firmware 3.5 and higher
- the module represents a DALI-line client and therefore it has its own DALI-address.
- double DALI terminals - the DALI signal line is connected through.



Specification, Characteristics

type	DALI PD	DALI PD 300W	
article number	86458618 (RL) 86458619 (RC) 86458619-25U (RLC)	86458618-300 (RL) 86458619-300 (RC) 86458619-300U(RLC)	86458619-300U-HS (RLC)

input: L, N

input type	mains	
marking terminals	L, N	
rated input voltage	220-240Vac	
input voltage frequency	50-60 Hz	
max. input power	25W	300W

input: DA, DA

input type	DALI, supply
marking terminals	DA, DA
input voltage range	9,5V ... 22,5V
max. current consumption DALI	6mA
number of DALI addresses	1

output: L', N

output type	trailing/leading edge phase cut of mains	
marking terminals	L', N bzw. 	
output voltage	like input L,N	
phase cut angle	0°-180°	
output voltage frequency	like input L,N	
max. output current	0.2A Eff ac	1.45A Eff ac
load range	3-25W	10-300W
max. length between device and luminaire	50m	

Insulation data:

impulse voltage category	II
pollution degree	2
rated insulation voltage	250V
insulation DALI (DA+,DA-) / (L/N/L')	reinforced isolation
insulation test voltage	3000Vac

environmental conditions:

storing and transportation temperature	-20°C ... +75°C
operational ambient temperature	-20°C ... +60°C
Rel. humidity, none condensing	15% ... 90%

general data:

dimensions (l x w x h)	59x33x15 mm	120x30x22mm	98x17,5x56mm
mounting	built-in, integration in protection class II devices	remote ceiling, integration in protection class II devices	dinrail, built-in, integration in protection class II devices
rated max. temperature tc	65°C		
expected life time @tc	50.000 h		
protection class	II in intended use		
protection degree housing	IP40		
protection degree terminals	IP20		

terminals:

Connection type	spring terminal connector	screw terminal
wire size solid core	0,5 ... 1,5 mm ² (AWG20 ... AWG16)	0,5 ... 2,5 mm ² (AWG20 ... AWG14)
wire size fine wired	0,5 ... 1,5 mm ² (AWG20 ... AWG16)	0,5 ... 2,5 mm ² (AWG20 ... AWG14)
wire size using wire end ferrule	0,25 ... 1 mm ²	0,25 ... 1,5 mm ²
stripping length	8,5 ... 9,5mm / 0,33 ... 0,37inch	7 mm / 0,27 inch
locking torque	-	0,5Nm
actuation type	Push button	screw

standards:

DALI	EN 62386-101, EN62386-102, EN62386-205
EMC	EN 61547

type PD 300W DIN Rail (98x17,5x56mm): 86458619-300U-HS (RLC):

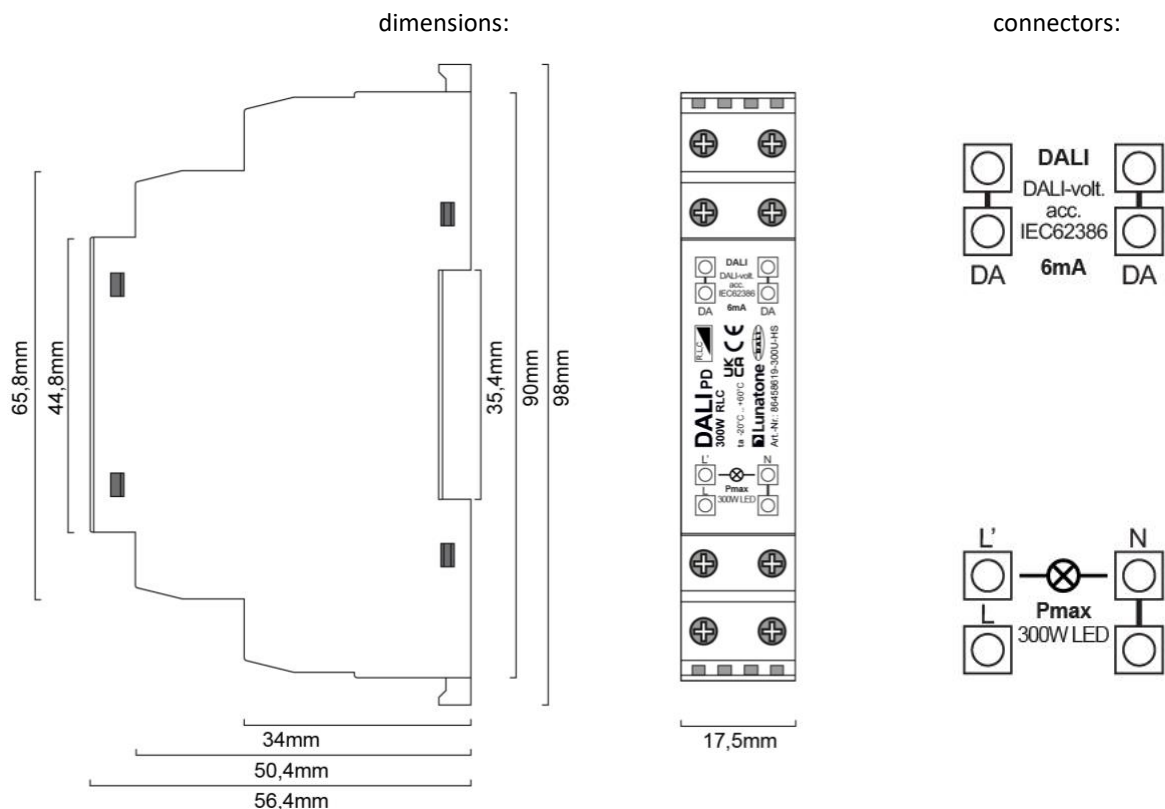

Factory Default Settings

Active Operating Mode	DT4
Min Level	3%
Max Level	100%
Power On Level	MASK (= last active value)
Fade Time	No fade
Fade Rate	44.7 steps/s (= 7)
System Failure Level	100%
Predefined scene values	none (MASK)
Broadcast control	active

Installation

- The DALI PD is suitable for integration in protection class II devices, ensure proper working cable relief for installation
- The DALI PD300 is an independent control gear and suitable for remote ceiling and integration in luminaires. When used as built-in in protection class II devices proper working cable relief has to be ensured
- The DALI PD300 (HS-type) is suitable for dinrail mounting, protection against shock has to be provided by an appropriate enclosure
- Wiring as fixed installation in a dry and clean environment
- Installation only by qualified person when no voltage is applied, even in case of only changing the luminaire no voltage must be applied.
- Attend regulations regarding electrical installations of national authorities
- Connect terminals L and N to mains
- Connect terminals L' and N or with the light bulb symbol to the load. Ensure that the wiring length to the load does not exceed 50m
- Do only connect luminaires that are in the rated power range of the dimmer and which are suitable with respect to the load type. Do also consider the power factor of the luminaires (especially for lamps with rated power below 25W)
- the connection to the DALI-line (DA, DA) is polarity free
- The DALI PD / DALI PD300 is supplied by the DALI-line (current consumption ~6mA)
- The DALI-line may be installed within the same cable or as single conductors within the same tube as mains supply
- The DALI-line must not be connected to the mains or other extra low voltage systems
- DALI-line wiring with standard low voltage installation material
- Wiring topology of the DALI-line: Line, Tree, Star



HINT: The DALI-signal is not classified as SELV circuit. Therefore the standards for installation in low voltage system apply.



The voltage drop on the DALI-line shall not exceed 2V.



ATTENTION: The intended use of DALI PD is dimming of LED-retrofit-luminaires, do not use with halogen lamps or magnetic transformers.

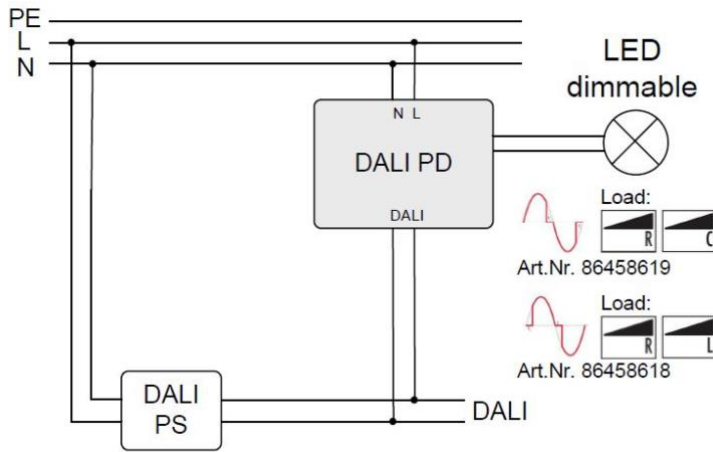

typical structure

ATTENTION:
Do not apply any potential to the light bulb connector!

Switch off mains supply before replacing the light bulb.

Leading edge phase cut dimmer (Art.Nr. 86458618):

dimmer type	suitable loads	note
		Not suitable for capacitive loads!

Trailing edge phase cut dimmer (Art.Nr. 86458619):

dimmer type	suitable loads	note
		Not suitable for inductive loads!

Universal dimmer (Art.Nr 86458619-xxxU):

dimmer type	suitable loads

ATTENTION: The intended use of DALI PD is dimming of LED-retrofit-luminaires, do not use with halogen lamps or magnetic transformers.

type of dimmers:

- Leading edge
- Trailing edge
- Universal

load:

- 3-25W: compact housing for back box installation
- 10-300W: remote ceiling, din rail

When connecting multiple bulbs the same load type has to be used (inductive or capacitive).

info universal dimmer:

suitable for resistive, inductive and capacitive loads.
After mains voltage is supplied the dimmer will recognize the load type and make a decision for leading edge phase cut operation (inductive load) or trailing edge phase cut operation (capacitive load)

Commissioning

- The DALI-PD is ready to use, it is supplied by the DALI-line (current consumption ~6mA)
- With the help of the DALI-Cockpit the DALI PD can be addressed and assigned to groups and scenes

Function

The DALI PD interface converts the DALI dim level into a voltage signal. The phase cut control generates a sinusoidal voltage with leading/trailing edge phase cut (logarithmic dimming characteristic corresponding to DALI). The operation mode (trailing/leading edge) can be queried via DALI (DT4). The PHYSICAL MINLEVEL is 3%.

Up from firmware version 3.5 an additional operating mode is supported. Instead of phase dimming (DT4) the device can act as switch (DT7 capable). Hence the switching characteristic is determined by the comparison of the virtual direct arc power level (VDAP) with 4 thresholds.

The virtual dim level (VDAP) is like the dim level of DALI-ballasts and is therefore limited by MINLEVEL and MAXLEVEL and influenced by fade-time and fade-rate.

For each dim direction 2 thresholds can be defined. They are compared with the virtual dim level and as a result the output is switched on or off:

virtual dim direction	comparison of virtual dim level and thresholds	output
UP	$VDAP \geq$ UP SwitchOn Threshold	ON
UP	$VDAP \geq$ UP SwitchOff Threshold	OFF
DOWN	$VDAP \leq$ DOWN SwitchOn Threshold	ON
DOWN	$VDAP \leq$ DOWN SwitchOff Threshold	OFF

If a threshold value is set to “MASK” the threshold is inactive and does not influence the relay output.

Find some examples of switching characteristics below:

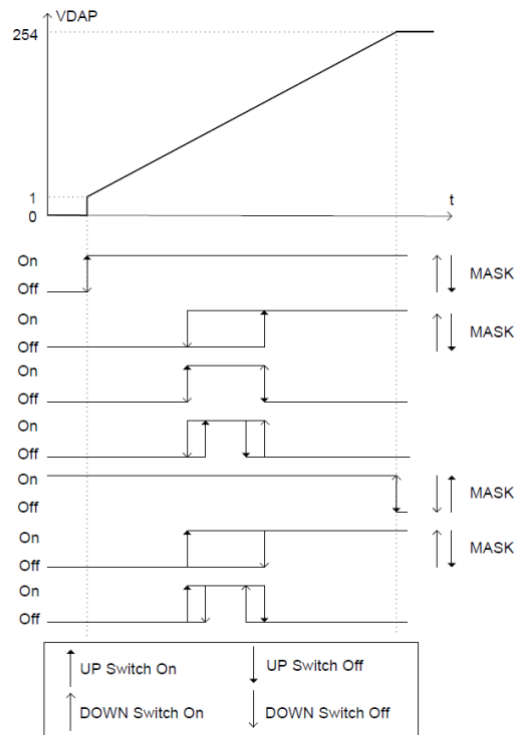

With the help of the fade time switch on and switch off delays can be realized.

Since the device is bus powered the configurable SYSTEM FAILURE LEVEL is not supported. In case of a DALI-line outage the DALI PD applies 100% at the output whereas at the output of the DALI PD300 0% are applied.

The Configuration can be done easily with the help of the DALI Cockpit:

General Settings:

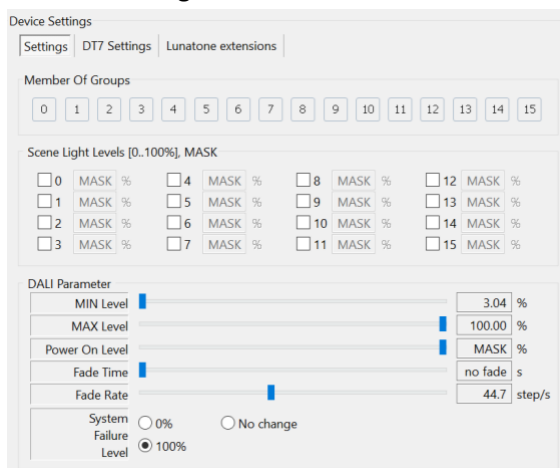

Lunatone Features:

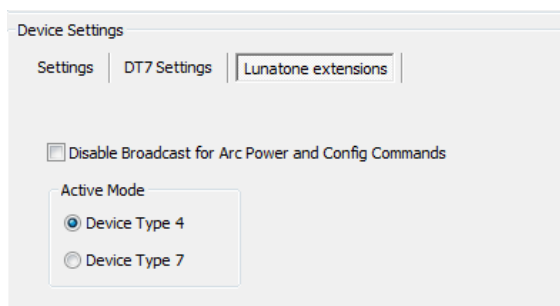

DT7 Settings:

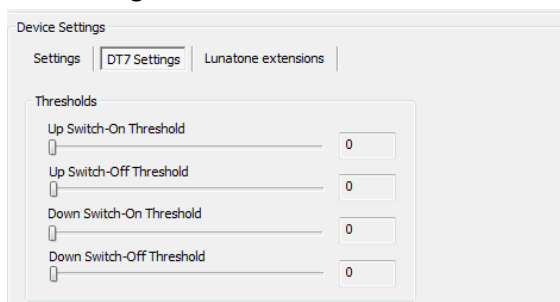

Purchase Order Information

article number: 864586xx – (extension)

86458618: leading edge dimmer (RL), 3-25W, back box

86458618-300: leading edge dimmer (RL), 10-300W, remote ceiling, din rail type on request

86458619: trailing edge dimmer (RC), 3-25W, back box

86458619-300 trailing edge dimmer (RC), 10-300W, remote ceiling, din rail type on request

86458619-25U: universal dimmer (RLC), 3-25W, back box

86458619-300U: universal dimmer (RLC), 10-300W, remote ceiling

86458619-300U-HS: universal dimmer (RLC), 10-300W, din rail

Additional Information and Equipment

DALI-Cockpit – free configuration tool from Lunatone for DALI systems

<http://lunatone.at/en/downloads/Lunatone-DALI-Cockpit.zip>

Lunatone DALI products

<http://www.lunatone.at/en/>

Lunatone datasheets and manuals

<http://lunatone.at/en/downloads/>

Contact

Technical Support: support@lunatone.com

Requests: sales@lunatone.com

www.lunatone.com

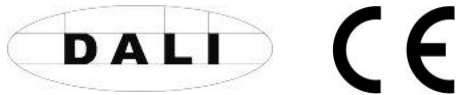

Disclaimer

Subject to change. Information provided without guarantee.
The datasheet refers to the current delivery.

The compatibility with other devices must be tested in advance
to the installation.