



DALI 4Net

Manual Central Control Device

Central Control Device for 4 DALI-lines

Version 0.3

DALI 4Net Central Control Device

Content

1.	DALI 4Net – Features and Installation	3
1.1	Intended Use	3
1.2	Safety Instructions	3
1.3	Features	3
1.4	Specification	3
1.5	Installation	4
2.	Basic Setup	5
2.1	General	5
2.2	Initial Connection to the DALI4Net.....	5
2.3	Change Network Settings	7
2.4	Change Date&Time.....	7
2.5	Addressing of DALI-lines.....	8
3.	Firmware Update.....	9
4.	DALI 4Net – ModBus TCP Access.....	10
4.1	General	10
4.2	Frame Structure.....	10
4.3	ModBus Commands	11
4.4	Frame Examples	11
4.5	ModBus Registers.....	12
4.6	Register Details.....	13
4.6.1	Register 1 – Polling Configuration	13
4.6.2	Register 10 – Network Configuration.....	13
4.6.3	Register 20 – System Configuration	13
4.6.4	Register 100 – Write DALI-Command.....	14
4.6.5	Register 101 – Read DALI Answer	15
4.6.6	Registers 9000 to 9063 – Query Actual Level and Short Address	15
4.6.7	Registers 9100 to 9163 – Query Status	15

1. DALI 4Net – Features and Installation

1.1 Intended Use

The DALI 4Net can be used for commissioning and control of DALI lighting systems. DALI is a standardized digital protocol for the control of electronic ballasts for lighting systems according to standard IEC62386. Exclusively ballast or control devices with DALI interface may be connected to one of the DALI-lines.

1.2 Safety Instructions

When operating the DALI 4Net the following precautions must be considered:

Each user must carefully read and follow the instructions given in the manual.

The operator must ensure that the wiring instructions and specifications for DALI lines are considered, the installation of the DALI 4Net must be performed by an qualified technician, who can perform the required tasks and recognize potential danger due to professional training, knowledge and experience, in particular the knowledge of pertinent regulations and standards.

1.3 Features

The DALI 4Net has connectors for four DALI lines (DALI 0-3). This allows installing up to 256 DALI ballasts and additional control devices.

1.4 Specification

article number	22176666
electrical data:	
rated supply voltage	24VDC
typ. current consumption	90 mA
Ethernet	1 x Ethernet 10/100Base-T, galvanic isolated 1500V AC, RJ45-connector
DALI	4 x DALI, galvanic isolated
technical data:	
ambient temperature	-10°C to +50°C
protection class	IP20
max. connecting wire crosssection	2,5 mm ²
mounting	dinrail
dimensions	98 x 17 x 56 mm

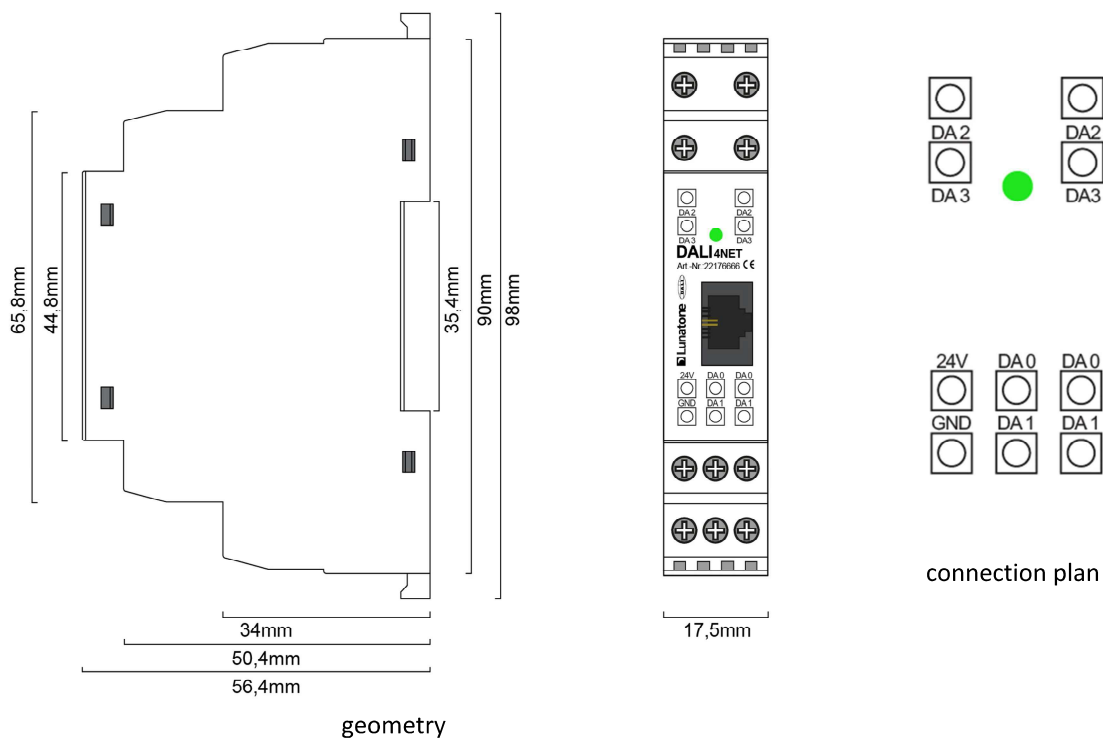

1.5 Installation

The DALI4Net does not provide any power supply for the DALI-lines. Therefore an external DALI power supply (e.g. DALI PS, Lunatone Art.Nr. 24033444) has to be installed for each DALI-line. For the power supply we recommend to use the PS24V from Lunatone (Art.Nr. 24166012-24HS) which is suited for dinrail mounting as well.

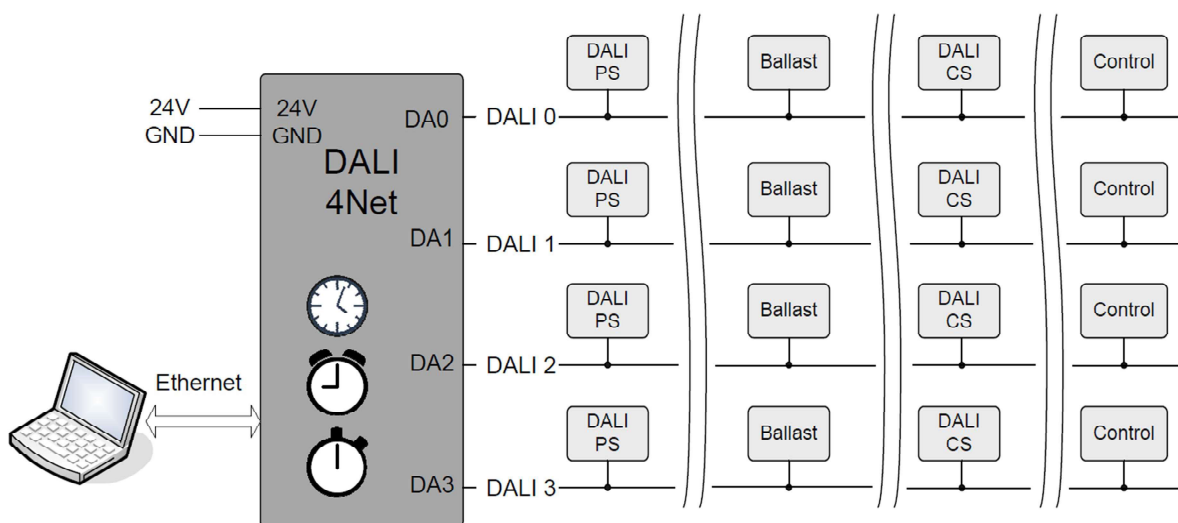

typical installation

2. Basic Setup

2.1 General

The DALI4Net can be set up with the help of the DALI Cockpit software tool. Furthermore all the configuration can be done via Modbus TCP/IP access as well. However, in this chapter we will deal with the setup in the Cockpit only.

2.2 Initial Connection to the DALI4Net

In the DALI Cockpit the interface you want to connect to can be defined in the bus server menu (menu **DALI-Bus -> Bus Interface**).

Select **Ethernet -> Lunatone TCP** and enter IP of the device. Alternatively the network can be scanned for devices (for this option use the "Search"-Button). The DALI4Net is delivered with the following default network settings:

IP-Adresse: 192.168.0.99
 Subnetmask: 255.255.255.0
 Gateway: 192.168.0.1

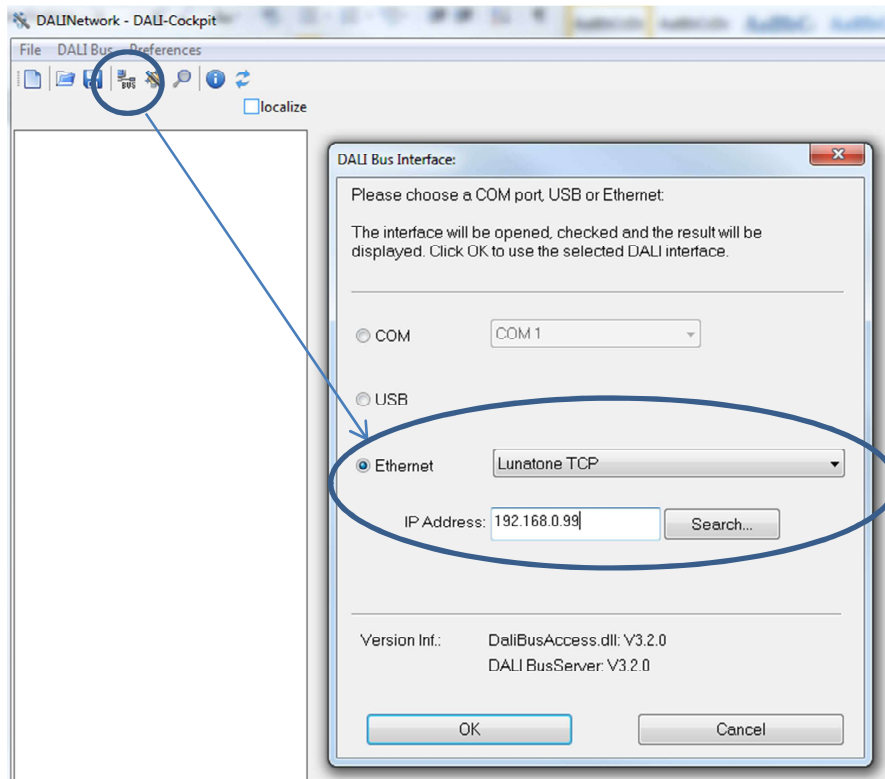

After an IP-address has been entered finally press “OK” to connect. You will then get a DALI4Net device in the component tree (on the left) and the corresponding menu on the right.

By selecting one of the 4 DALI-lines (DALI 0 ... DALI3) the corresponding menu of the DALI-line can be entered.

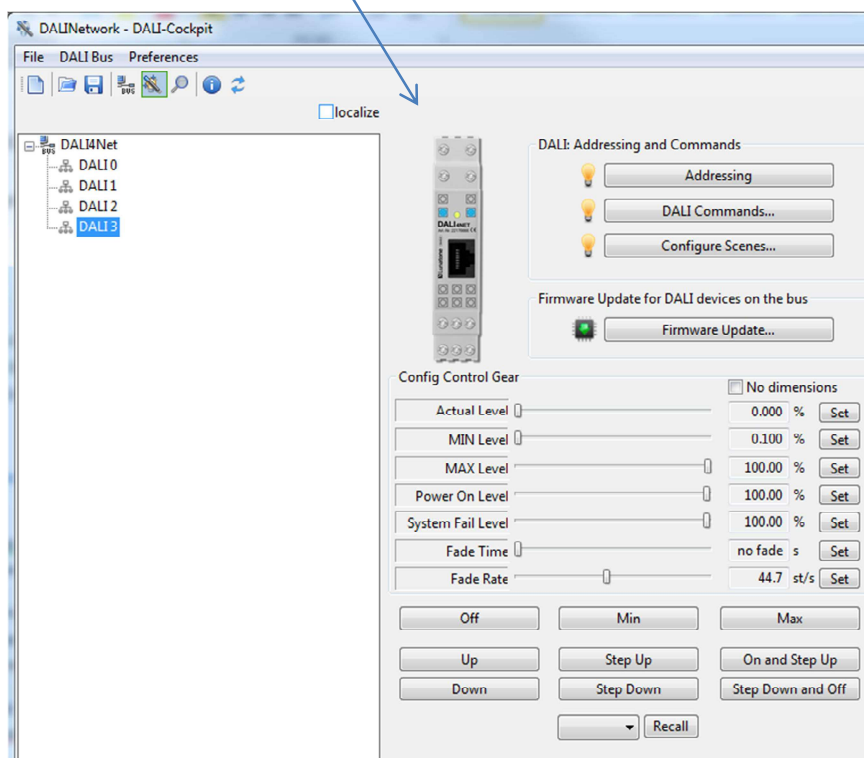
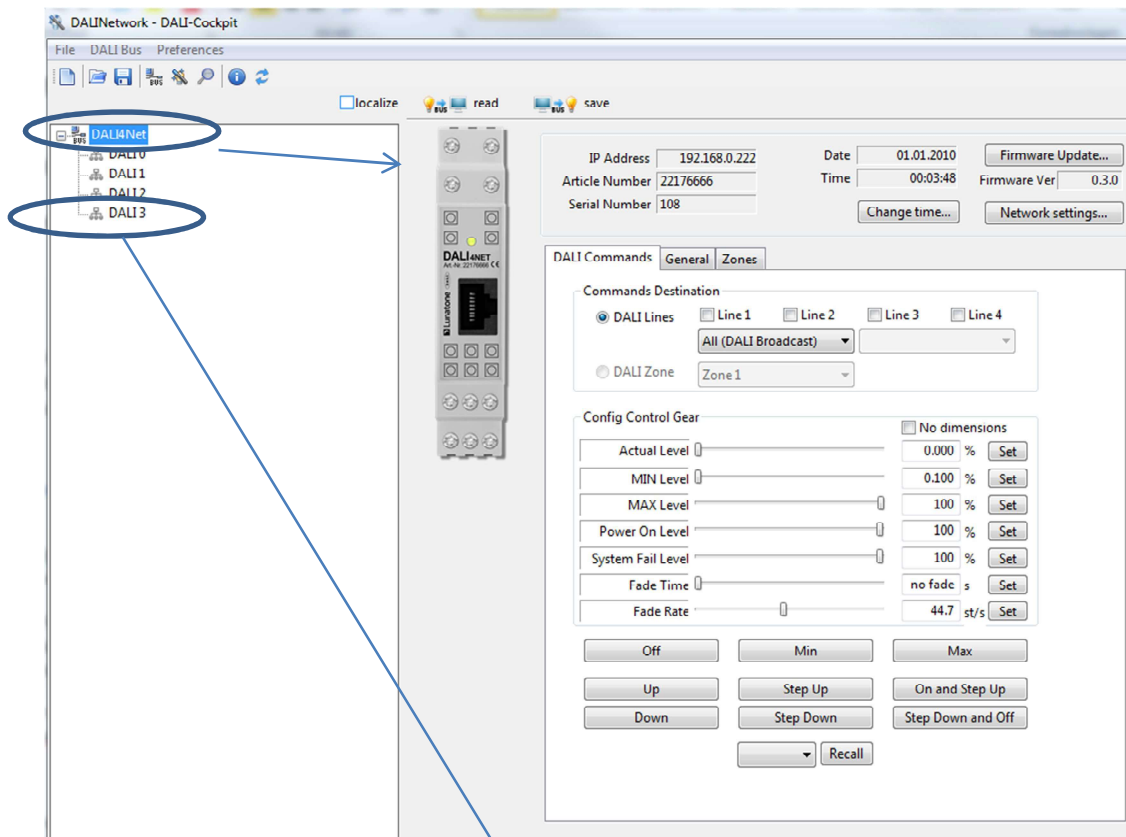

2.3 Change Network Settings

In the Network settings you can set up a static IP address or if the IP should be obtained by a DHCP-server.

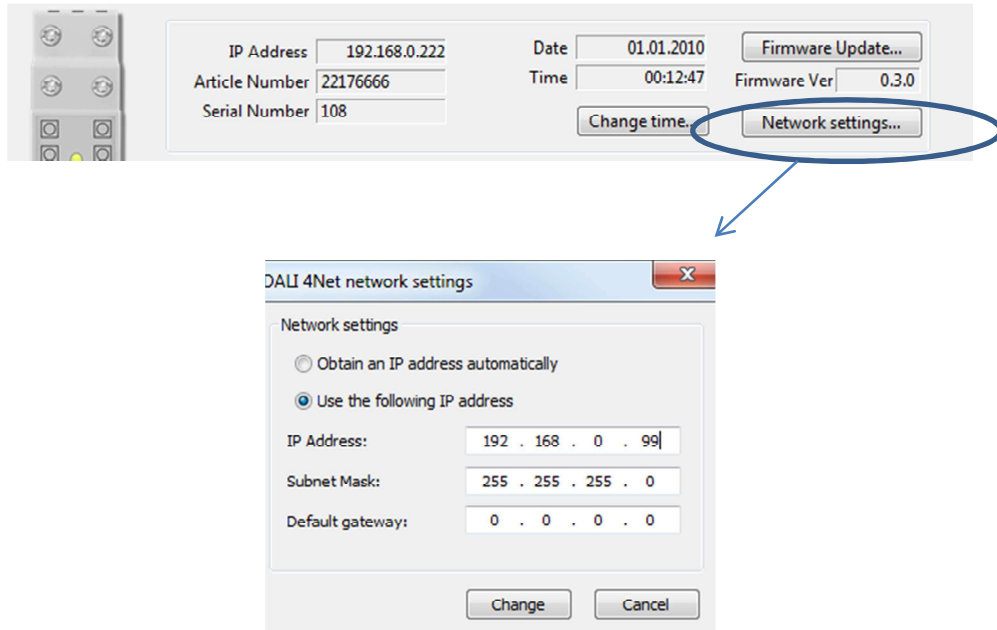

2.4 Change Date&Time

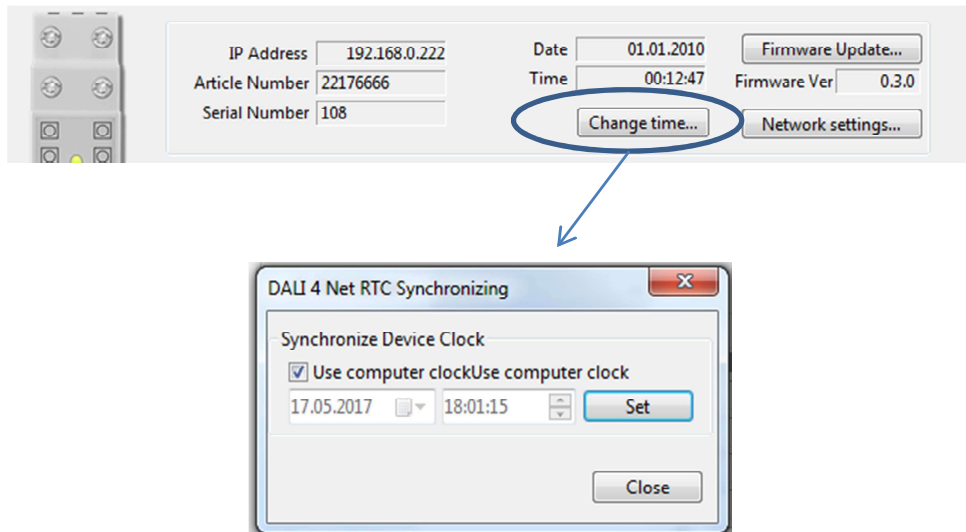

2.5 Addressing of DALI-lines

The DALI-Cockpit provides a simple menu for each DALI-line which allows addressing, testing and configuration of the DALI-line. It can be accessed by selecting the corresponding DALI-line in the component tree.

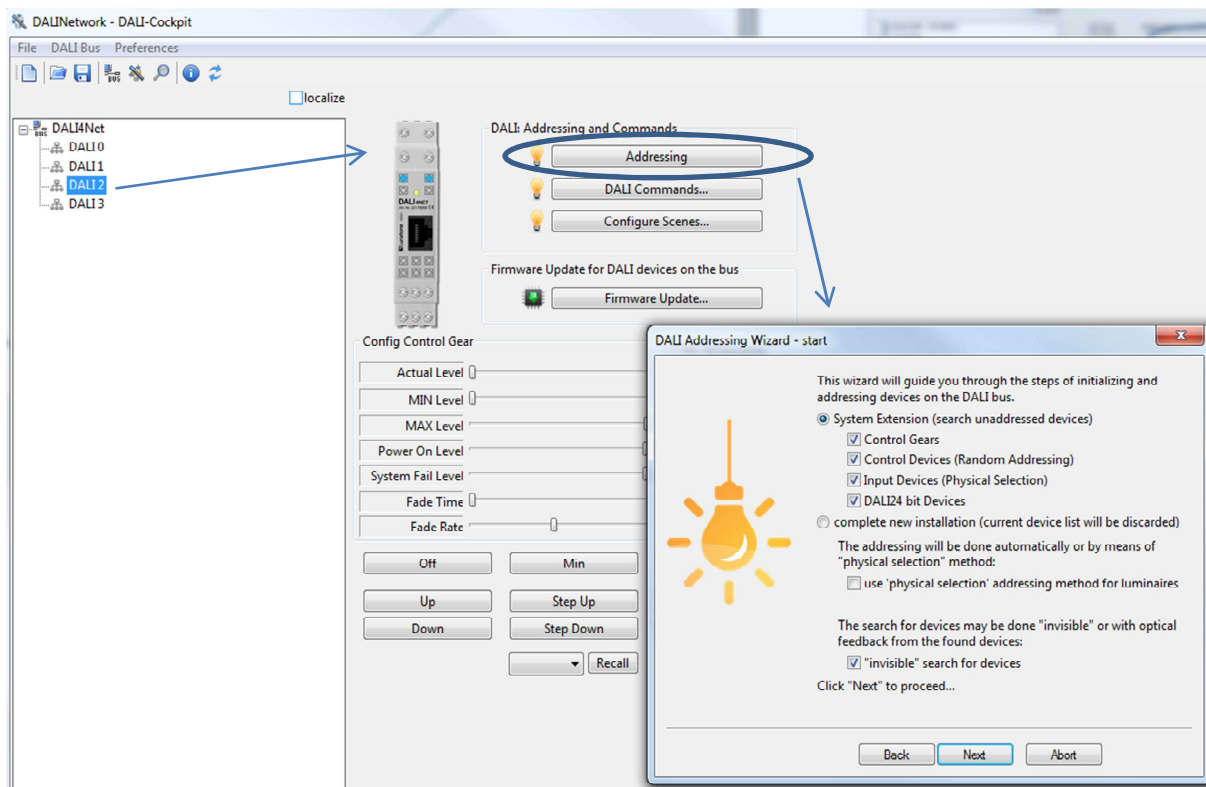

When setting up a DALI-line we recommend testing the communication first. With the help of the control buttons on the bottom of the site (e.g. OFF, MIN, MAX) the devices on the DALI-line can be controlled broadcast. In the second step the devices have to be addressed. There are two options:

System Extension:

- Searching for addressed devices
- Addressing unaddressed devices

Complete New Installation:

- Deleting all existing addresses and group assignments
- Addressing unaddressed devices

When addressing input devices you will be asked for double press buttons of the input devices. The order of the activity can be used for spatial localization of the input devices.

When addressing is finished all devices are listed as subset of the DALI-line in the component tree.

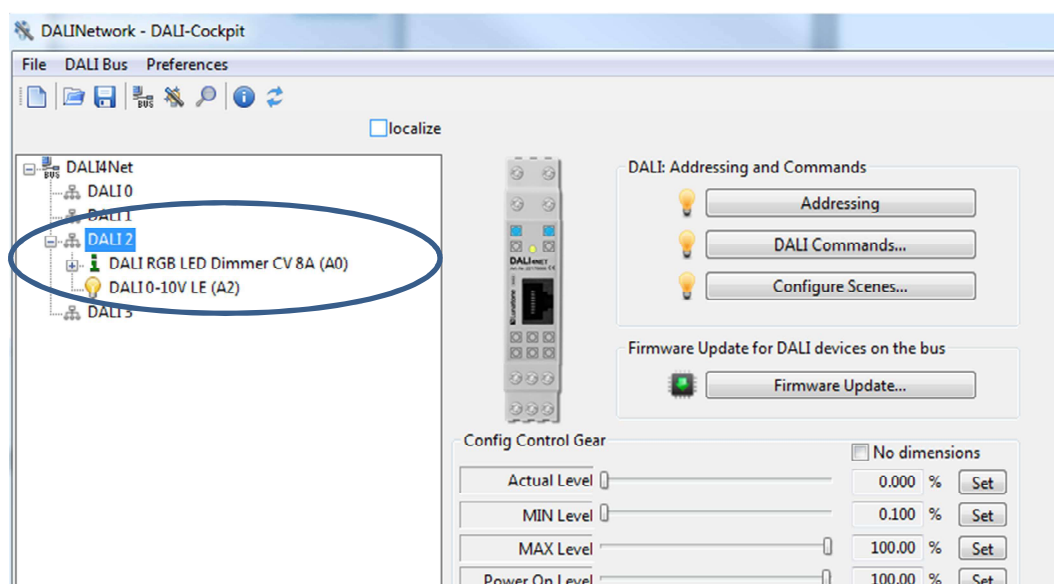

Each component listed in the component tree can be selected and configured. The procedure is the same for each DALI-line.

3. Firmware Update

To ensure that all features explained in the manual are supported by your DALI4Net check the Lunatone website for firmware updates. If a newer version is available download and install it as described below:

Press the “Firmware Update” button, afterwards a window will appear where you can enter the name of the file.

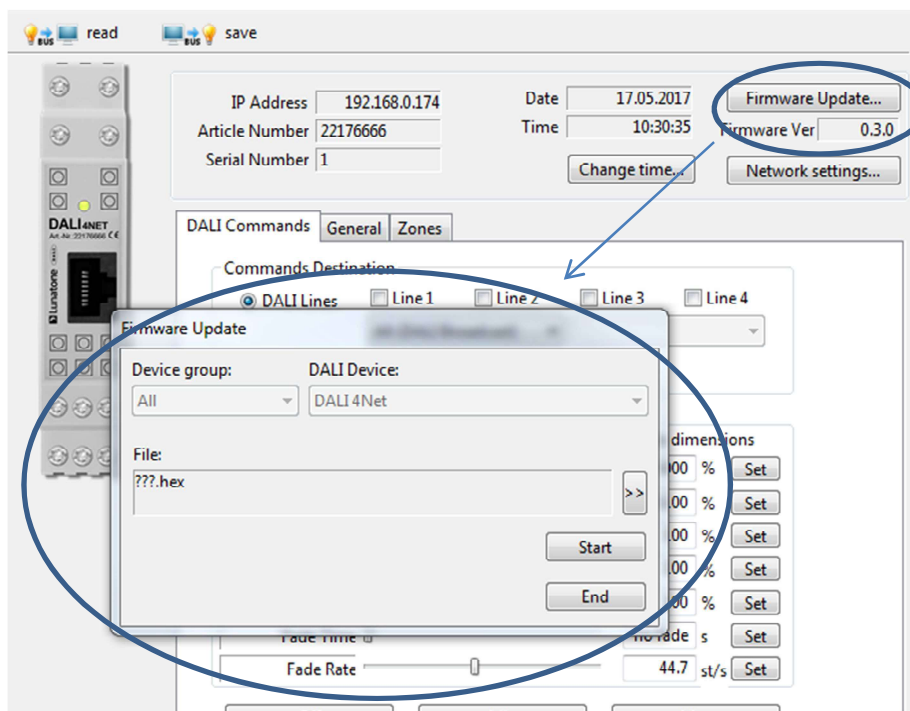

After firmware update the DALI4Net will reboot.

4. DALI 4Net – ModBus TCP Access

4.1 General

Modbus TCP/IP ist a type of the serial modbus protocol for TCP/IP networks using port 502. The Modbus standard provides several functions for data exchange.

4.2 Frame Structure

Modbus TCP/IP Frame has a header called “MBAP Header” and consists of the following 7 byte:

Name	Length (bytes)	Function
Transaction identifier	2	For synchronization between messages of server & client
Protocol identifier	2	Zero for Modbus/TCP
Length field	2	Number of remaining bytes in this frame
Unit identifier	1	Slave address (255 if not used)
Function Code	1	Modbus Function Codes as described below
Data	n	Number of bytes as needed

In the DALI4Net the “Unit identifier” is used to select which bus is addressed for certain registers. It’s used in this format:

ZZZZBBBB (binary):

Z .. Zones: 1-15, 0 means bus selection is active

B .. Bus line: Binary selection for bus lines

This is i.e. used for sending Dali commands. With the help of the unit identifier DALI commands can be sent either to zones or multiple DALI-lines.

4.3 ModBus Commands

Supported Modbus functions:

Function Name	Function Code	Description
Read Multiple Holding Registers	03	Read Data Blocks From Device
Write Multiple Holding Registers	16	Write Data Blocks To Device
Read/Write Holding Registers	23	First Write, then Read from Specific Address, function used to send DALI commands

With the help of the mentioned functions Modbus registers can be accessed and data can be exchanged between a modbus client and the server.

4.4 Frame Examples

Read multiple registers (FC 03):

Request

- Byte 0: 03 (Read multiple registers)
- Byte 1-2: Register Address (also called „reference number“)
- Byte 3-4: Word count (1-125)

Response

- Byte 0: 03 (Read multiple registers)
- Byte 1: Byte count of response
- Remaining Bytes: Register values

Exceptions

- Byte 0: FC = 0x83
- Byte 1: exception code = Illegal Function (01) or Illegal Data Address (02)

Write multiple registers (FC 16):

Request

- Byte 0: 0x10 (Write multiple registers)
- Byte 1-2: Register Address (also called „reference number“)
- Byte 3-4: Word count (1-100)
- Byte 5: Byte count
- Remaining Bytes: Register values

Response

- Byte 0: 0x10 (Write multiple registers)
- Byte 1-2: Register Address (also called „reference number“)
- Byte 3-4: Word count

Exceptions

- Byte 0: FC = 0x90
- Byte 1: exception code = Illegal Function (01) or Illegal Data Address (02)

Read/Write registers (FC 23):

Request

- Byte 0: 0x17 (Read/Write registers)
- Byte 1-2: READ Register Address (also called „read reference number“)
- Byte 3-4: Word count for read (1-125)
- Byte 5-6: WRITE Register Address (also called „write reference number“)
- Byte 7-8: Word count for write (1-100)
- Byte 9: Byte count
- Remaining Bytes: Register values

Response

- Byte 0: 0x17 (Read/Write registers)
- Byte 1: Byte count
- Remaining Bytes: Register values

Exceptions

- Byte 0: FC = 0x97
- Byte 1: exception code = Illegal Function (01) or Illegal Data Address (02)

4.5 ModBus Registers

Register	Name	Length (Word)	Read/Write	Function
1	Polling Configuration	4	RW	Enable/Disable Polling from Dali4Net
10	Network Configuration	7	RW	Read/Write Network Configuration (DHCP or static)
20	System Configuration	32	R (W partial)	Read System Configuration and Write Nametag
100	Write Dali Command	6	W	Write Dali Command (100&101 used with FC 23)
101	Read Dali Command	5	R	Read Answer from previously sent Command
9000-9063	Query Actual Level and Short Address	1	R	Query Actual level and Short Address of given devices
9100-9163	Query Status	1	R	Query Dali Status and Extended Status of given devices

4.6 Register Details

4.6.1 Register 1 – Polling Configuration

If polling is activated, the DALI4Net cyclically polls status and actual level of the DALI ballasts. If polling is inactive the status and actual level of the device may be wrong (you will then receive the internal calculated reference value of the ballast which in most cases is correct, but can deviate e.g. in case of communication error or lamp failure).

Polling Configuration			
Byte	Name	Line	Description
0	Config	0	Bit 0: 1=Enable 0=Disable
1	Reserved		Reserved for future use
2	Config	1	Bit 0: 1=Enable 0=Disable
3	Reserved		Reserved for future use
4	Config	2	Bit 0: 1=Enable 0=Disable
5	Reserved		Reserved for future use
6	Config	3	Bit 0: 1=Enable 0=Disable
7	Reserved		Reserved for future use

4.6.2 Register 10 – Network Configuration

With the network configuration you can read out and configure the network settings. After changing the network settings the device will reboot. The default network settings are:

Static IP:
 IP-Address: 192.168.0.99
 Subnetmask: 255.255.255.0
 Gateway: 192.168.0.1

Network Configuration		
Byte	Name	Description
0	DHCP	0x01=DHCP 0x00=Static
1-4	IP Address	i.e. 1=192 2=168 3=0 4=99
5-8	Subnet Mask	i.e. 5=255 6=255 7=255 8=0
9-12	Gateway	i.e. 9=192 10=168 11=0 12=1

4.6.3 Register 20 – System Configuration

With Modbus register 20 you can read out info about hardware, firmware, serial, production data etc. Furthermore you can set a name for the device with a maximum length of 30 characters.

System Configuration		
Byte	Name	Description
0-29	Nametag	Up to 30 characters nametag
30-31	HW Version	Major.Minor
32-35	Serialnumber	4 Byte serial number
36-39	Articlenumber	4 Byte article number
40	LTDT	Lunatone specific device type
41	Build number	FW Version build number
42	FW Minor	FW Version minor
43	FW Major	FW Version major
44-45	Production	Week,Year
46-63	Info	Device info

4.6.4 Register 100 – Write DALI-Command

For direct access to the DALI-lines Modbus Register 100 and 101 are used.

Write Dali Command		
Byte	Name	Description
0	CmdByte	Command Byte = 0x12 always
1	Sequence number	Command Sequence number (will be sent back)
2	Control	Command Control byte Bit 7: unused, set to 0 Bit 6: if set no data is sent out on the DALI line (used to test connection status) Bit 5: sent twice, cmd will be sent twice on DALI-line (required for some DALI commands) Bit 4: Send DTR before DALI command Bit 3: Send DALI Device Type before DALI command Bit 2: Send "Set Actual Level to DTR" before DALI command
3	Mode	Command Mode Byte Value: 0,1: not used 2: send DALI answer (8Bit, DATA_LO) 3: send DALI (16 Bit, DATA_MID, DATA_LO) 4: send eDALI (25Bit, DATA_HI, DATA_MID, DATA_LO) 5: DSI 6: send 3Byte DALI (24Bit, DATA_HI, DATA_MID, DATA_LO) 7: reserved 8: send 17bit Helvar 16bits: DATA_MID, DATA_LO, 17 th . bit: DATA_HI) 12: reserved
4	Reserved	
5	Dali High	Highest Dali Byte (DATA_HI)
6	Dali Mid	Mid Dali Byte (DATA_MI)
7	Dali Low	Low Dali Byte (DATA_LO)
8	DTR	Value to be set to DTR
9	Priority	Priority for dali command
10	Device type	Device type to be sent

4.6.5 Register 101 – Read DALI Answer

Read Dali Command		
Byte	Name	Description
0	Cmd Byte	Command Byte = 0x12 always
1	Status	Command Status byte: High nibble: identifier, value =7 Low nibble: status 0: OK 1: DALI answer ="NO" 2: DALI 8bit data 3: DALI 16bit data 4: DALI 25bit data (eDALI) 5: DSI 6: DALI 24bit data 7: Error/Info, if set: Check sum: DATA_LO=1; DALI-line short circuit: DATA_LO=2; DALI receive error: DATA_LO=3; DALI bus back to ok: DATA_LO=4; Switch to DSI-mode: DATA_LO=5; Switch to DALI-mode: DATA_LO=6;
2	Reserved	Reserved
3	Reserved	DALI_HI
4	Reserved	DALI_MI
5	Answer	DALI_LO (answer to previous command)
6	Reserved	
7	Sequence number	Command sequence number same as previously sent

4.6.6 Registers 9000 to 9063 – Query Actual Level and Short Address

Query actual level and short address of DALI control gear. The actual level of up to 64 device can be read with one command only.

Query Actual Level and Short address (ballasts)		
Byte	Name	Description
Use Unit identifier for Bus selection! Command is usable for up to 64 registers which are equal to dali addresses. 9000 with 1 word would return level and address from control gear 0. 9000 with 64 words returns actual level and address of all control gears.		
0	Actual level	Dali actual level
1	Short address	Dali short address (255 if unaddressed > no device)

4.6.7 Registers 9100 to 9163 – Query Status

Query status of DALI control gear. The status of up to 64 device can be read with one command only. The status includes the DALI device status and info about communication. This query only makes sense if automatic polling (ModBus Register 1) is activated – otherwise the answer can differ from the current status of the DALI devices.

Query Status (ballasts)		
Byte	Name	Description
Uses Unit identifier for Bus selection! Command is usable like command 9000.		
0	Extended Status	AxxxxxC(bin) → A .. device is addressed, C .. Communication Error (device is not answering to poll)
1	Dali Status	Dali device status